

Thick film rectangular

MCR10 (2012 size: 1 / 8W)

●Features

- 1) Power rating of 1 / 8W
- 2) Highly reliable chip resistor
Ruthenium oxide dielectric offers superior resistance to the elements.
- 3) Electrodes not corroded by soldering
Thick film makes the electrodes very strong.
- 4) Leading the world in development and mass production.

Since start of production in 1982 (a world first), this component has established a solid reputation as a general-purpose chip resistor.

- 5) ROHM resistors have approved ISO-9001 certification.

Design and specifications are subject to change without notice. Carefully check the specification sheet before using or ordering it.

●Ratings

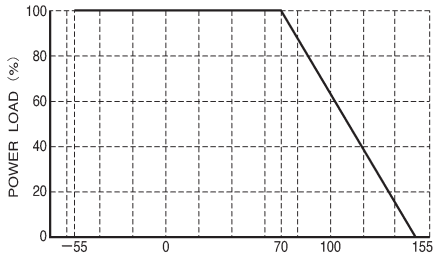
Item	Conditions	Specifications	
Rated power	<p>Power must be derated according to the power derating curve in Figure 1 when ambient temperature exceeds 70°C.</p>  <p style="text-align: center;">Fig.1</p>	0.125W (1 / 8W) [0.100W (1 / 10W)] * at 70°C	
Rated voltage	<p>The voltage rating is calculated by the following equation. If the value obtained exceeds the maximum operating voltage, the voltage rating is equal to the maximum operating voltage.</p> $E = \sqrt{P \times R}$ <p style="text-align: right;"> E: Rated voltage (V) P: Rated power (W) R: Nominal resistance (Ω) </p>	Max. operating voltage	150V
		Max. overload voltage	200V (300V) *
		Max. intermittent overload voltage	200V (300V) *
Nominal resistance	See Table 1.		
Operating temperature		-55°C to +155°C	

* At power rating of 0.1W, maximum overload voltage and maximum intermittent overload voltage are 300V.

Jumper type

Resistance	Max. 50mΩ
Rated current	2A
Peak current	10A
Operating temperature	-55°C to +155°C

Table 1

Resistance tolerance		Resistance range (Ω)	Resistance temperature coefficient (ppm / °C)
F (±1%)		10≤R≤2.2M (E24,96)	±100
J (±5%)	JB*	0.68 (E6)	500±350
	J	1.0≤R<2.2 (E24)	
		2.2≤R<10 (E24)	
		10≤R<10M (E24)	±200

Asterisk (*) indicates special specifications.

- Before using components in circuits where they will be exposed to transients such as pulse loads (short-duration, high-level loads), be certain to evaluate the component in the mounted state. In addition, the reliability and performance of this component cannot be guaranteed if it is used with a steady state voltage that is greater than its rated voltage.

●Characteristics

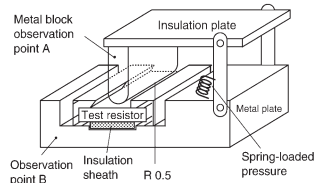
Characteristics	Specifications		Test method
	Chip resistance	Jumper type	
DC resistance	F : $\pm 1\%$ J : $\pm 5\%$	Max. 50m Ω	JIS C 5202 5.1 Applied voltage: A
Resistance temperature characteristics	See Table 1.		JIS C 5202 5.2 Test conditions: +25 / -55 / +25 / +125°C
Short time overload	$\pm (2.0\% + 0.1 \Omega)$	Max. 50m Ω	JIS C 5202 5.5 Rated voltage (current): $\times 2.5$, 5s. Maximum overload voltage: 200V
Insulation resistance	Min. 1,000M Ω between terminal and board		JIS C 5202 5.6 Test voltage: 100V, 1min. <u>Assembled state</u> 
Withstand voltage	Do not damage insulation or cause a short circuit.		JIS C 5202 5.7 Test voltage: 500V
Intermittent overload	$\pm (5.0\% + 0.1 \Omega)$	Max. 50m Ω	JIS C 5202 5.8 Rated voltage (current): $\times 2.5$ (1s: ON - 25s: OFF) $\times 10,000$ cyc.
Terminal strength (against bending of circuit board)	$\pm (1.0\% + 0.05 \Omega)$ There must be no mechanical damage.	Max. 50m Ω	JIS C 5202 6.1
Resistance to soldering heat	$\pm (1.0\% + 0.05 \Omega)$ Outside must not be noticeably damaged.	Max. 50m Ω	JIS C 5202 6.4 Soldering conditions: 260 $\pm 5^\circ\text{C}$ Soldering time: 10 ± 1 s.
Solderability	95% of terminal surface must be covered by new soldering, and there must be no soldering corrosion.		JIS C 5202 6.5 Rosin methanol: (25%WT) Soldering conditions: 235 $\pm 5^\circ\text{C}$ Soldering time: 2.0 ± 0.5 s.
Resistance to dry heat	$\pm (3.0\% + 0.1 \Omega)$	Max. 100m Ω	JIS C 5202 7.2 155°C Test time: 1,000 to 1,048 hrs.
Endurance (under load in damp environment)	$\pm (3.0\% + 0.1 \Omega)$	Max. 100m Ω	JIS C 5202 7.10 Rated voltage (current), 70°C 1.5h: ON - 0.5h: OFF Test time: 1,000 to 1,048 hrs.
Endurance (steady state)	$\pm (3.0\% + 0.1 \Omega)$	Max. 100m Ω	JIS C 5202 7.9 Rated voltage (current), 60°C, 90%RH 1.5h: ON - 0.5h: OFF Test time: 1,000 to 1,048 hrs.
Resistance to humidity (steady state)	$\pm (3.0\% + 0.1 \Omega)$	Max. 100m Ω	JIS C 5202 7.5 85°C, 85%RH Test time: 1,000 to 1,048 hrs.
Temperature cycling	$\pm (1.0\% + 0.05 \Omega)$	Max. 50m Ω	JIS C 5202 7.4 Test temperature: -55°C to +125°C 100cyc.
Resistance to solvents	$\pm (0.5\% + 0.05 \Omega)$ Markings must not be dissolved away.	Max. 50m Ω	JIS C 5202 6.9 Room temperature, static immersion, 1 min. Solvent: Isopropyl alcohol

External dimensions (Units: mm)

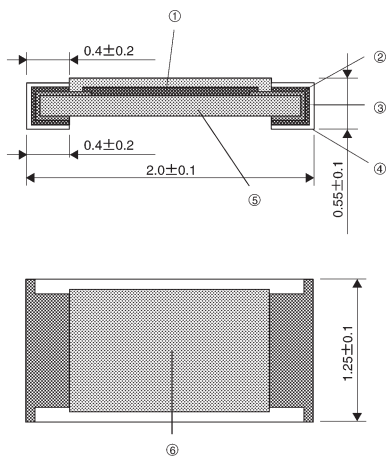

No.	Material
①	Thick dielectric glaze of ruthenium (only silver used for jumper)
②	Thick film of palladium-silver for primary electrode
③	Nickel-coated secondary electrode
④	External electrode coated with tin and lead
⑤	Alumina substrate
⑥	Overcoating

Packaging

Reel

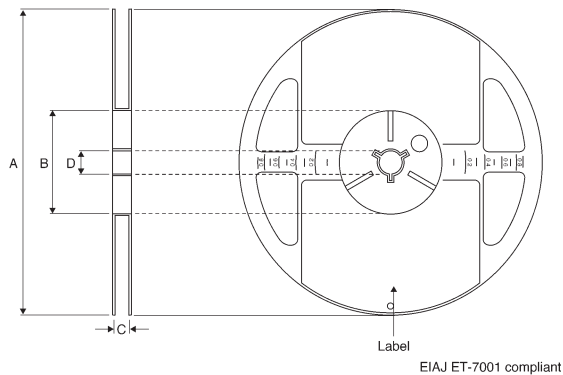

(Units : mm)

A	B	C	D
$\phi 180 \begin{smallmatrix} 0 \\ -3 \end{smallmatrix}$	$\phi 60 \begin{smallmatrix} +1 \\ 0 \end{smallmatrix}$	9 ± 0.3	$\phi 13 \pm 0.2$
$\phi 268 \pm 1.5$	$\phi 100 \pm 0.8$	9.4 ± 0.5	$\phi 13 \pm 0.3$
$\phi 330 \pm 2$	Min. $\phi 80$	9.5 ± 0.5	$\phi 13 \pm 0.2$

Taping

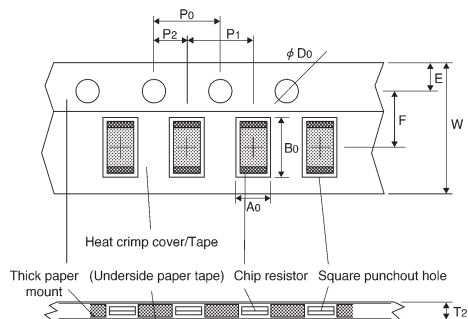

(Units : mm)

W	F	E	A ₀	B ₀
8.0 ± 0.3	3.5 ± 0.05	1.75 ± 0.1	$1.65 \begin{smallmatrix} +0.2 \\ -0.1 \end{smallmatrix}$	$2.4 \begin{smallmatrix} +0.2 \\ -0.1 \end{smallmatrix}$
D ₀	P ₀	P ₁	P ₂	T ₂
$\phi 1.5 \begin{smallmatrix} +0.1 \\ 0 \end{smallmatrix}$	4.0 ± 0.1	4.0 ± 0.1	2.0 ± 0.05	Max. 1.1

Bulk case

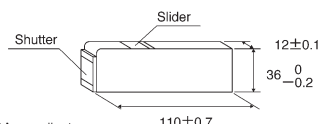

EIAJ ET-7201A compliant

(Units : mm)

●Part designation

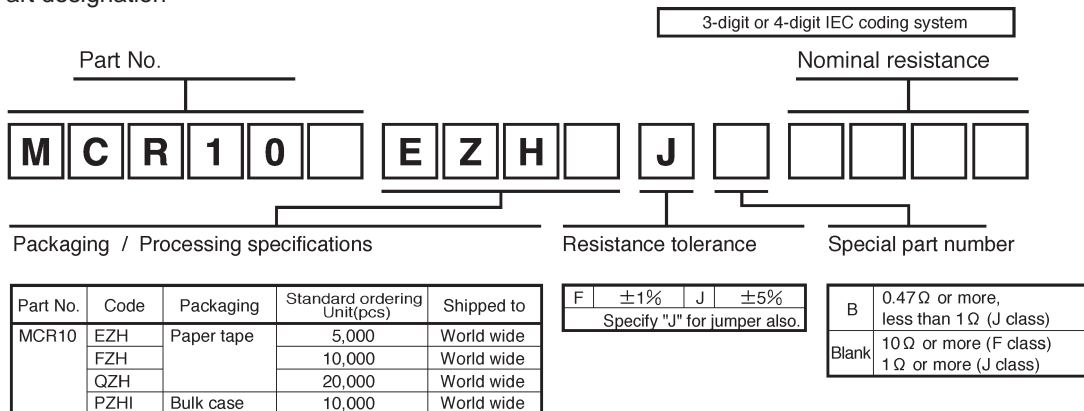

●Dimensions

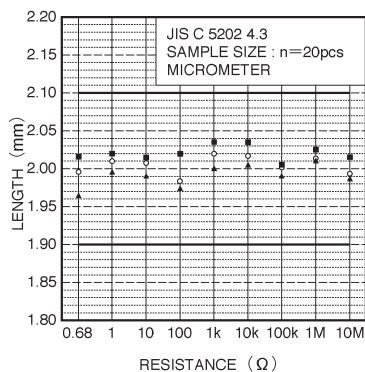

Fig.2 Dimensions (length)

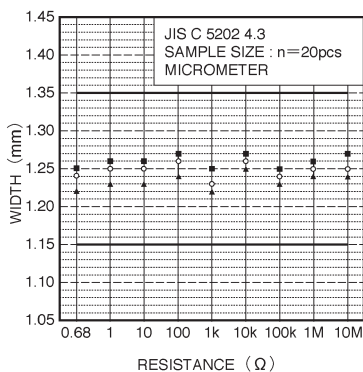

Fig.3 Dimensions (width)

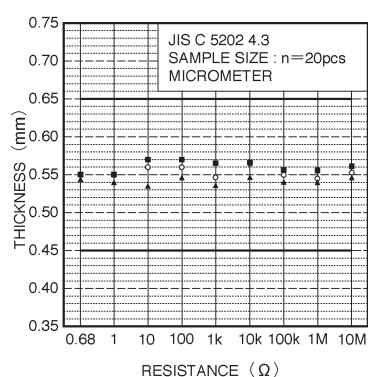

Fig.4 Dimensions (thickness)

●Electrical characteristics

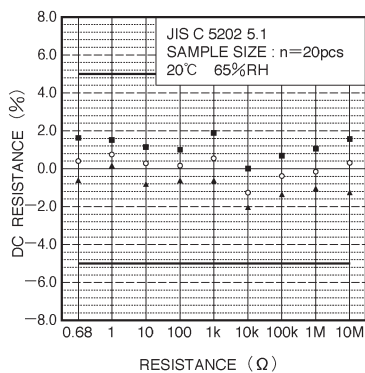

Fig.5 DC resistance

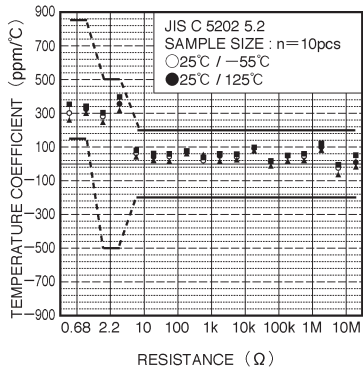

Fig.6 Resistance temperature characteristics

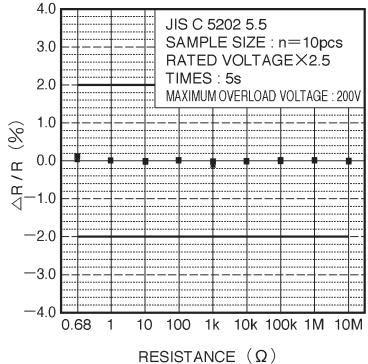

Fig.7 Short time overload

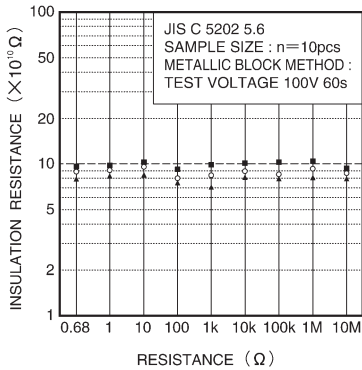

Fig.8 Insulation resistance

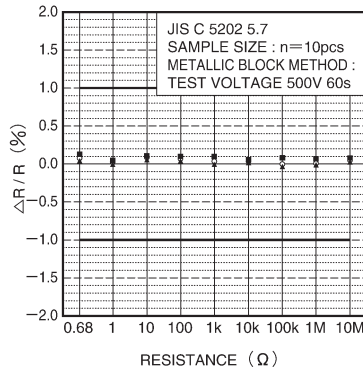

Fig.9 Withstand voltage

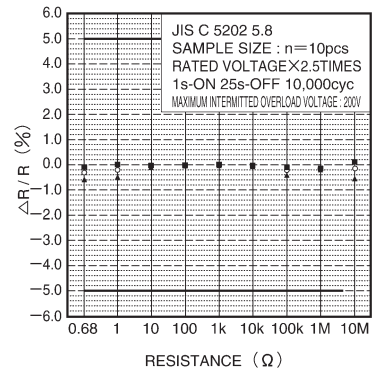

Fig.10 Intermittent overload

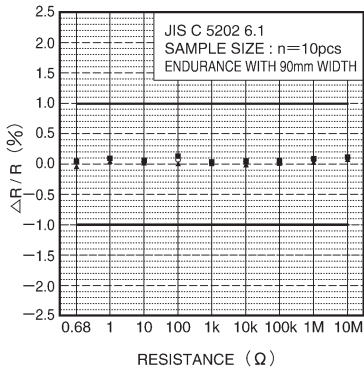

Fig.11 Terminal strength (bending strength characteristics)

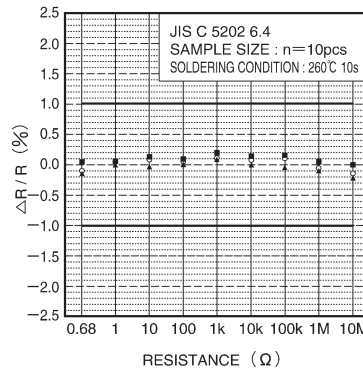

Fig.12 Resistance to soldering heat

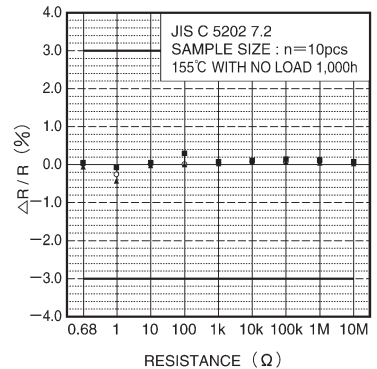

Fig.13 Resistance to dry heat

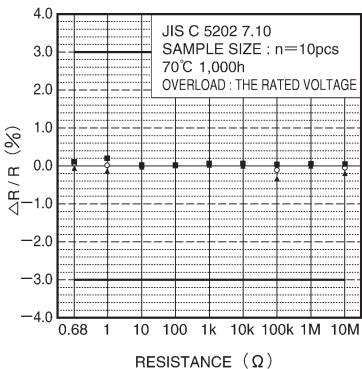

Fig.14 Endurance (rated load)

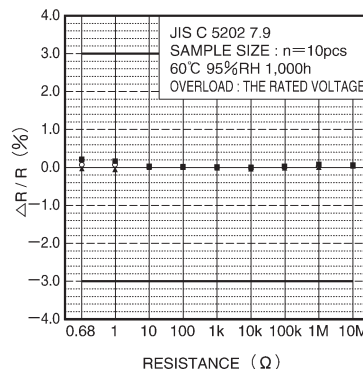

Fig.15 Endurance (under load in damp environment)

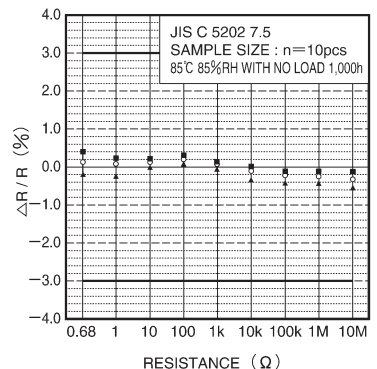

Fig.16 Resistance to humidity (steady state)

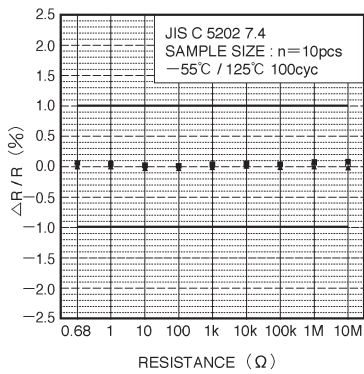

Fig.17 Temperature cycling

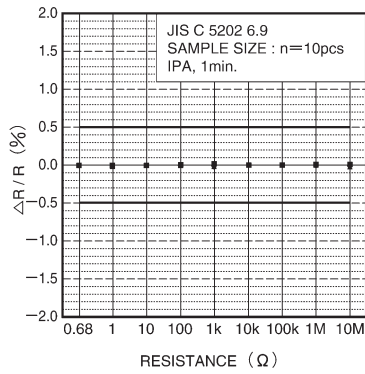

Fig.18 Resistance to solvents